

# Multilayer Chip Directional Couplers For W-CDMA/Tx

Conformity to RoHS Directive

## HHM Series HHM2220SA3

### SHAPES AND DIMENSIONS

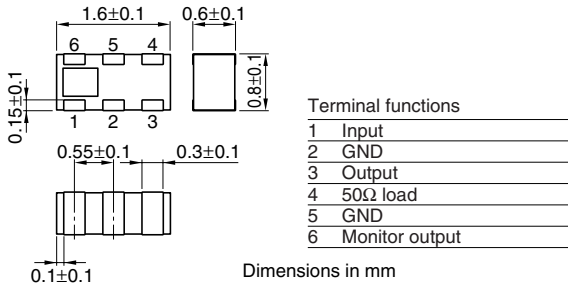

### CIRCUIT DIAGRAM

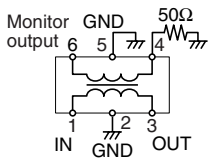

### RECOMMENDED PC BOARD PATTERNS

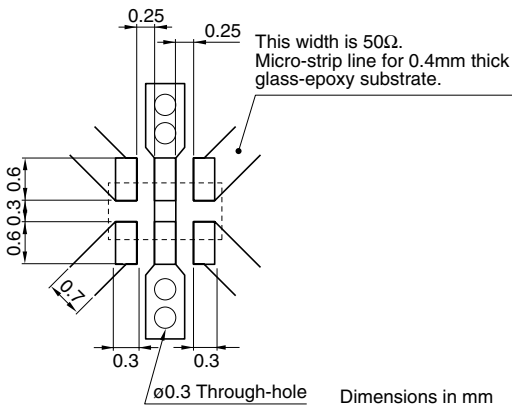

### ELECTRICAL CHARACTERISTICS

Frequency range	1920 to 1980MHz
Coupling factor	-16.0±1.0dB
Insertion loss	0.30dB max.*1 0.35dB max.*2
Isolation	25dB min.
VSWR	1.4 max.
Temperature range	Operating -40 to +85°C Storage -40 to +85°C

\*1 25°C

\*2 Operating temperature

• Conformity to RoHS Directive: This means that, in conformity with EU Directive 2002/95/EC, lead, cadmium, mercury, hexavalent chromium, and specific bromine-based flame retardants, PBB and PBDE, have not been used, except for exempted applications.

• All specifications are subject to change without notice.

### FREQUENCY CHARACTERISTICS

#### COUPLING

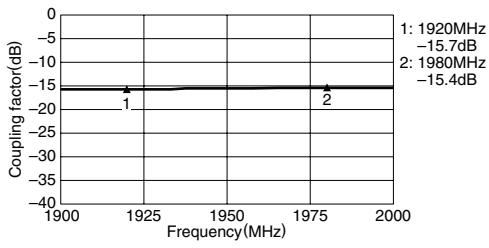

#### ISOLATION

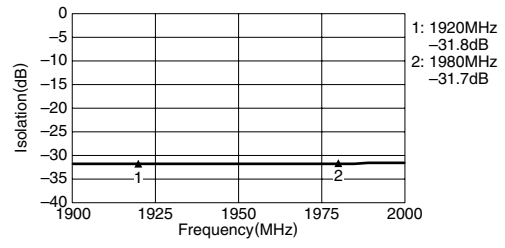

#### INSERTION LOSS

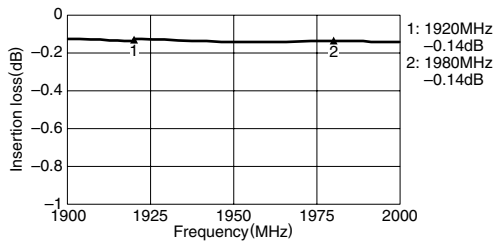

#### VSWR

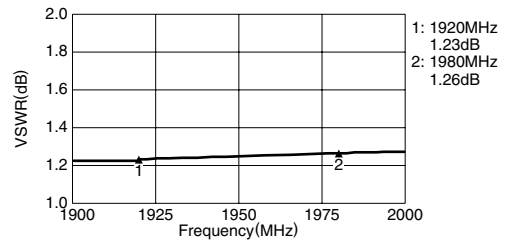

• All specifications are subject to change without notice.